

Spare parts list

Edition 081016

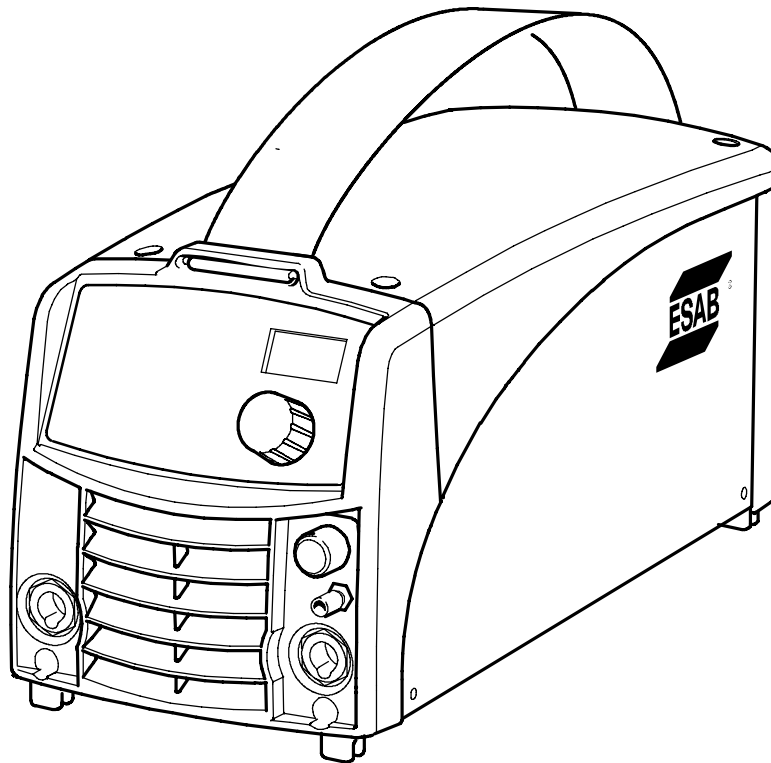

Valid for serial no. 803-xxx-xxxx, 828-xxx-xxxx, 843-xxx-xxxx

Ordering no.	Product	
0460 450 881	Caddy™ Tig 2200i, TA33	230 V 50/60 Hz incl. MMA-kit, TXH 200
0460 450 883	Caddy™ Tig 2200i, TA34	230 V 50/60 Hz incl. MMA-kit, TXH 200
0460 450 884	Caddy™ Tig 2200iw, TA33	230 V 50/60 Hz incl. MMA-kit, TXH 250, CoolMini
0460 450 885	Caddy™ Tig 2200iw, TA34	230 V 50/60 Hz incl. MMA-kit, TXH 250, CoolMini
0460 450 891	Caddy™ Tig 2200i, TA33	230 V 50/60 Hz incl. return cable, gas hose
0460 450 893	Caddy™ Tig 2200i, TA34	230 V 50/60 Hz incl. return cable, gas hose
0460 450 894	Caddy™ Tig 2200iw, TA33	230 V 50/60 Hz incl. return cable, gas hose, CoolMini
0460 450 895	Caddy™ Tig 2200iw, TA34	230 V 50/60 Hz incl. return cable, gas hose, CoolMini
0460 450 871	Caddy™ Tig 2200i, TA33 Australian version	230 V 50/60 Hz incl. MMA-kit, TXH 200
0460 450 873	Caddy™ Tig 2200i, TA34 Australian version	230 V 50/60 Hz incl. MMA-kit, TXH 200

Spare parts are to be ordered through the nearest ESAB agency. Kindly indicate type of unit, serial number, denominations and ordering numbers according to the spare parts list.

Maintenance and repair work should be performed by an experienced person, and electrical work only by a trained electrician. Use only recommended spare parts.

Rights reserved to alter specifications without notice.

Tig 2200i

C = component designation in the circuit diagram

Item	Qty	Ordering no.	Denomination	Notes	C	
AA1	1	0193 317 001	Switch	Included in item AA50	2QF1	
AA2	1	-	Cord set	Included in item AA50		
AA3	1	0460 140 001	Rear panel			
AA4	1	0460 143 001	Cover			
AA5	1	0460 250 882	MMC Module TA34	Control panel Including Insulation snticker, AA6 and AA7		
	1	0460 250 886	MMC Module TA33	Control panel Including Insulation snticker, AA6 and AA7		
	1	0460 420 001	Insulation sticker	Included in AA5		
AA6	1	0460 600 528	Knob	Included in AA5		
AA7	1	0193 700 711	Ribbon cable with connectors	34 pole, included in AA5		1XS1, 1XS2
AA8	1	0460 479 002	Side panel	right		
	1	0460 426 002	Side panel	right for Tig 2200iw		
AA9	1	0460 479 001	Side panel	left		
	1	0460 426 001	Side panel	left for Tig 2200iw		
AA10		0194 179 327	Screw MRT	ground cutter, M5x12		
AA11	1	-	Front panel	Included in item AA51		
AA12	1	0459 184 005	Sticker	ESAB		
AA13	1	0460 221 006	Sticker	Tig 2200i		
AA14	5	0366 588 001	Nut			
AA15	1	-	Socket	2 pole Included in item AA51 and AA52	29XS4	
AA16	1	0457 626 001	Protection cap	Included in item AA51		
AA17	1	0460 427 001	Bar plus			
AA18	1	-	Nut	Included in item AA51, M8		
AA19	1	0459 269 002	Gas connection	Included in item AA51		
AA20	6	0469 381 002	Fast lock nut	M5		
AA21	1	0194 227 003	Clamp	Only TA34 Included in item AA51		
AA22	1	0458 681 897	Cable with connectors	Only TA34 Included in item AA51		20XS25, 20XP1
AA23	1	0366 285 001	Protection cap	Only TA34 Included in item AA51		
AA24	2	0366 247 001	Nut	Included in item AA51		
AA25	2	0366 306 003	Spring washer	Ø21/15x1 Included in item AA51		
AA26	2	0160 362 025	Connector OKC 50	Included in item AA51	XS1, XS2	
AA27	1	0460 265 001	Strap			
AA28	2	0468 497 001	Holder			
AA29	1	0193 700 702	Ribbon cable			

Tig 2200i

SPARE PARTS SETS

Item	Ordering no.	Denomination	Notes
AA50	0460 601 880	Mains module	Includes items: AA1 switch, AA2 mains cable with plug, cable clamp and one ferrite rings 2L2.
	0460 601 883	Mains module	Includes items: AA11, AA15, AA16, AA18, AA19, AA21, AA22, AA23, AA24, AA25, AA26. Australian version
AA51	0460 379 881	Front complete TA34	Includes items: AA11, AA15, AA16, AA18, AA19, AA21, AA22, AA23, AA24, AA25, AA26
	0460 379 882	Front complete TA33	Includes items: AA11 AA15, AA16, AA18, AA19, AA24, AA25, AA26
AA52	0459 280 892	Cable set	Including item AA15, 2 pole socket 29XS4, 5 pole socket 29XS6, and the wires between them.

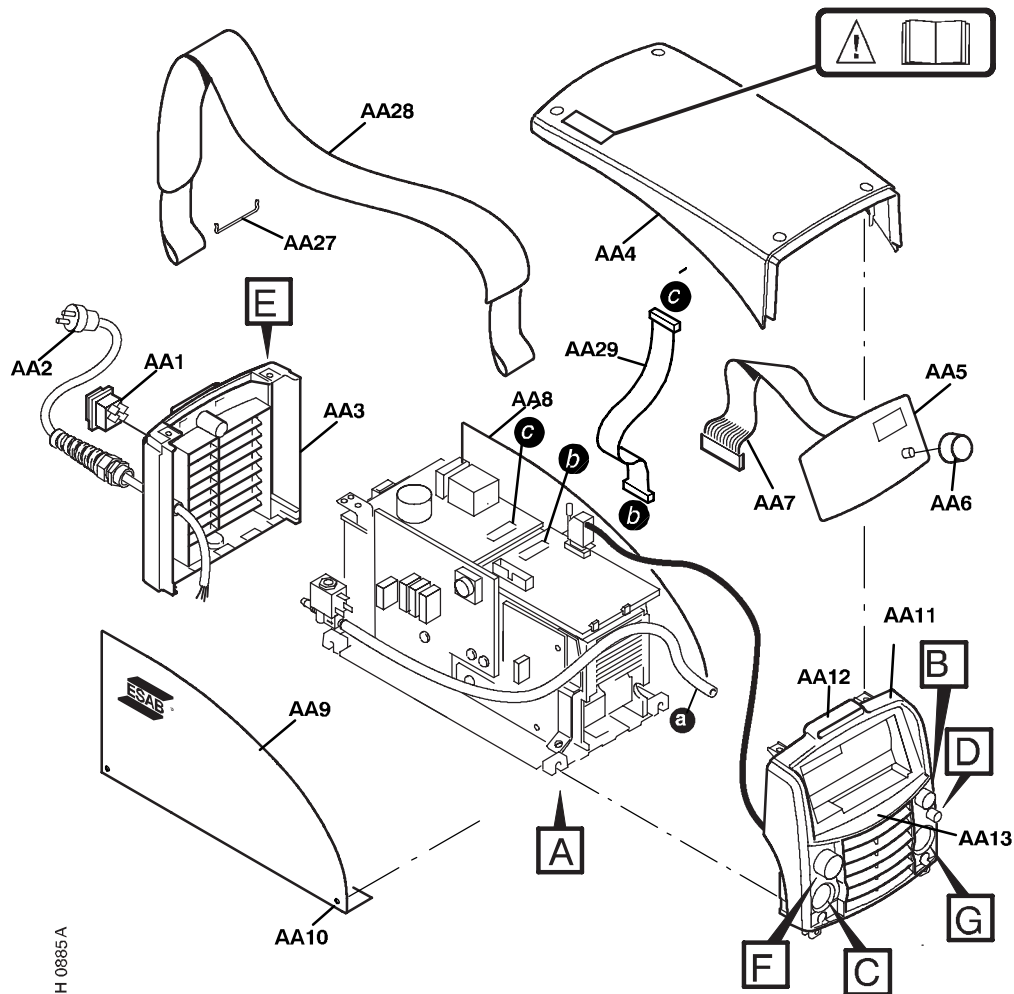

AH 0885 A

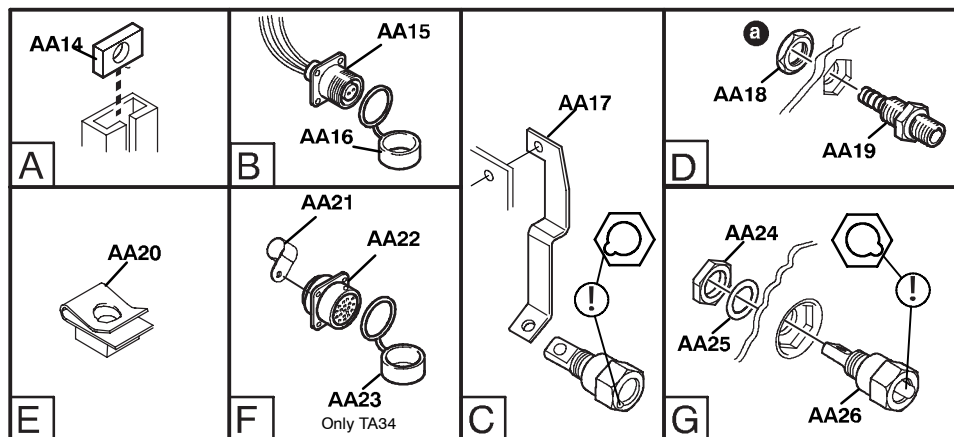

C = component designation in the circuit diagram

Item	Qty TA33	Qty TA34	Ordering no.	Denomination	Notes	C
AB1	1	1	0487 631 880	Power supply board		2AP1
AB2	1	1	0193 700 702	Ribbon cable with connectors	10 pole	20XS3, 20XS4
AB3*	-	1	0487 344 885	Control board	Configured for Tig 2200i TA34	20AP1
	1	-	0487 344 884	Control board	Configured for Tig 2200i TA33	20AP1
	1	-	0487 344 889	Control board	Configured for Tig 2200i TA33/VRD	20AP1
AB4	1	1	0468 940 005	Thermal switch	Socket connector 15XS5 included	15ST2
AB5	1	1		Diode module	See item AB50	15D1
AB6	1	1	0459 177 001	Inductor		15L1
AB7	1	1	0459 355 881	Transformer	Includes: main transformer, sockets 15XS4, 15XS6, thermal switch 15ST1	15TM1
AB8	1	1	0460 117 001	Inductor	PFC	15L2
AB9	1	1	0194 158 003	Capacitor	1000 uF 450 V DC	15C1
AB10			0487 060 880	Secondary board		15AP2
AB11	1	1		Circuit board	See item AB51	15AP1
AB12	1	1		Semiconductor module	See item AB51	
AB13	1	1	0468 030 880	Shunt		15RS1
AB14	1	1	0459 194 001	Busbar		
AB15	1	1	0458 065 002	Fan	24 V DC; with cables and socket 15XS3	15EV1

* Item AB3, control board 20AP1:

Version TA34 is delivered with the VRD deactivated, the VRD can be activated by ESAT.

For version TA33 there are two options with or without VRD (as this can not be changed by ESAT).

SPARE PARTS SETS

Item	Qty	Ordering no.	Denomination	Notes
AB50	1	0459 385 881	Diode module kit	Includes: item AB5 diode module, screws (type A and B), thermal compound and roller.
AB51	1	0459 384 884	Power board kit	Includes: item AB11 power board, item AB12 semiconductor module, screws (type A and B), thermal compound and roller.
-		0458 910 002	Roller handle	For the roller in the spare parts sets above
-		0192 058 101	Thermal compound	

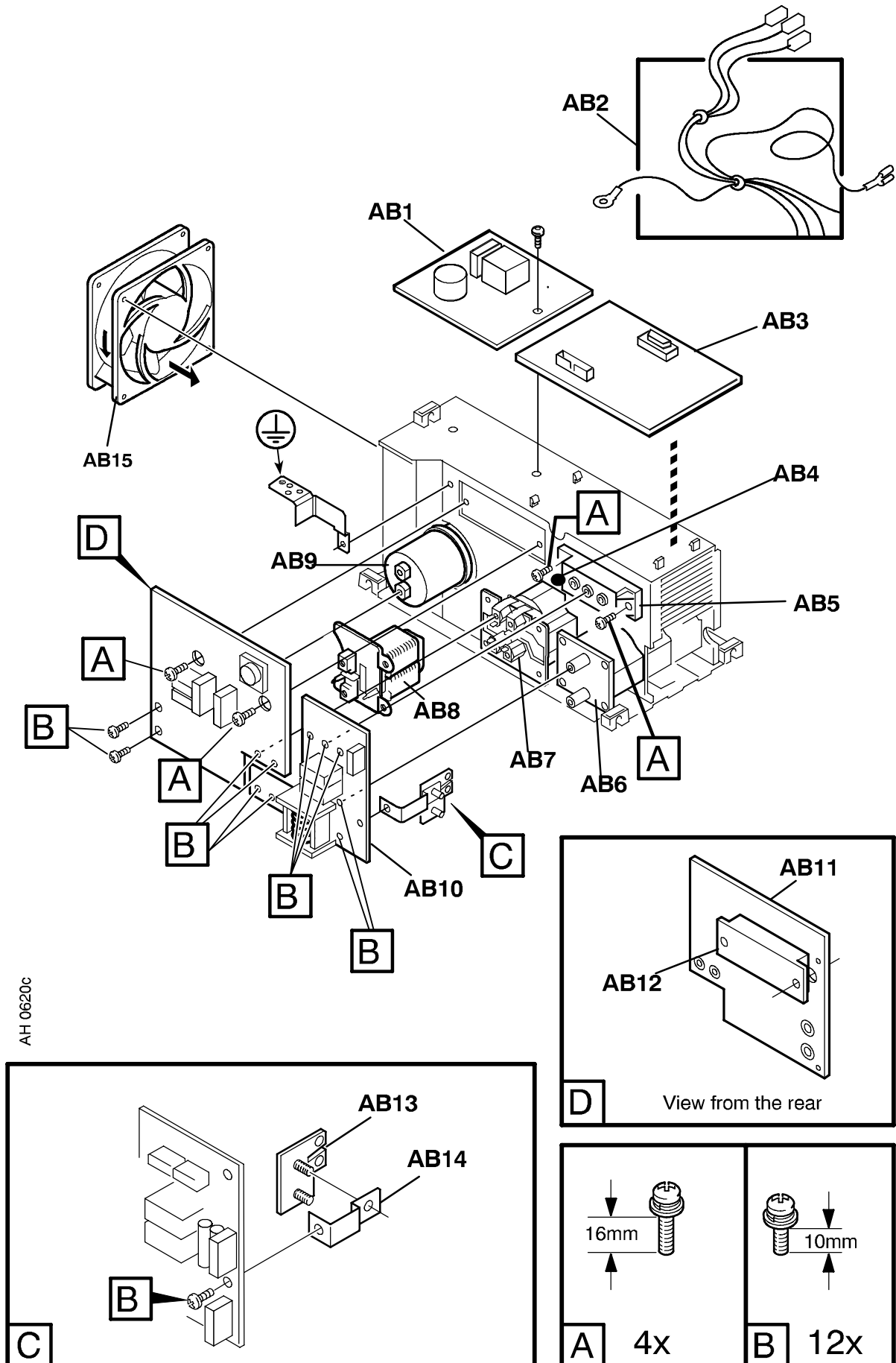

Tig 2200i**C = component designation in the circuit diagram**

Item	Qty	Ordering no.	Denomination	Notes	C
AC1	1	0193 054 005	Solenoid valve	230 V AC	10YV1
AC2	1		Nut	ML6M MF10x1	
AC3	1	0456 496 001	Hose	D = 9/5 mm, L = 0.57 metre reinforced PVC	
AC4	1	0487 028 880	Circuit board TIG		10AP1
AC5	1	0459 258 001	Coil bracket		
AC6	1	0460 135 001	HF coil		10TV1, 10XS1
AC7	1	0460 427 002	Bar	Negative	



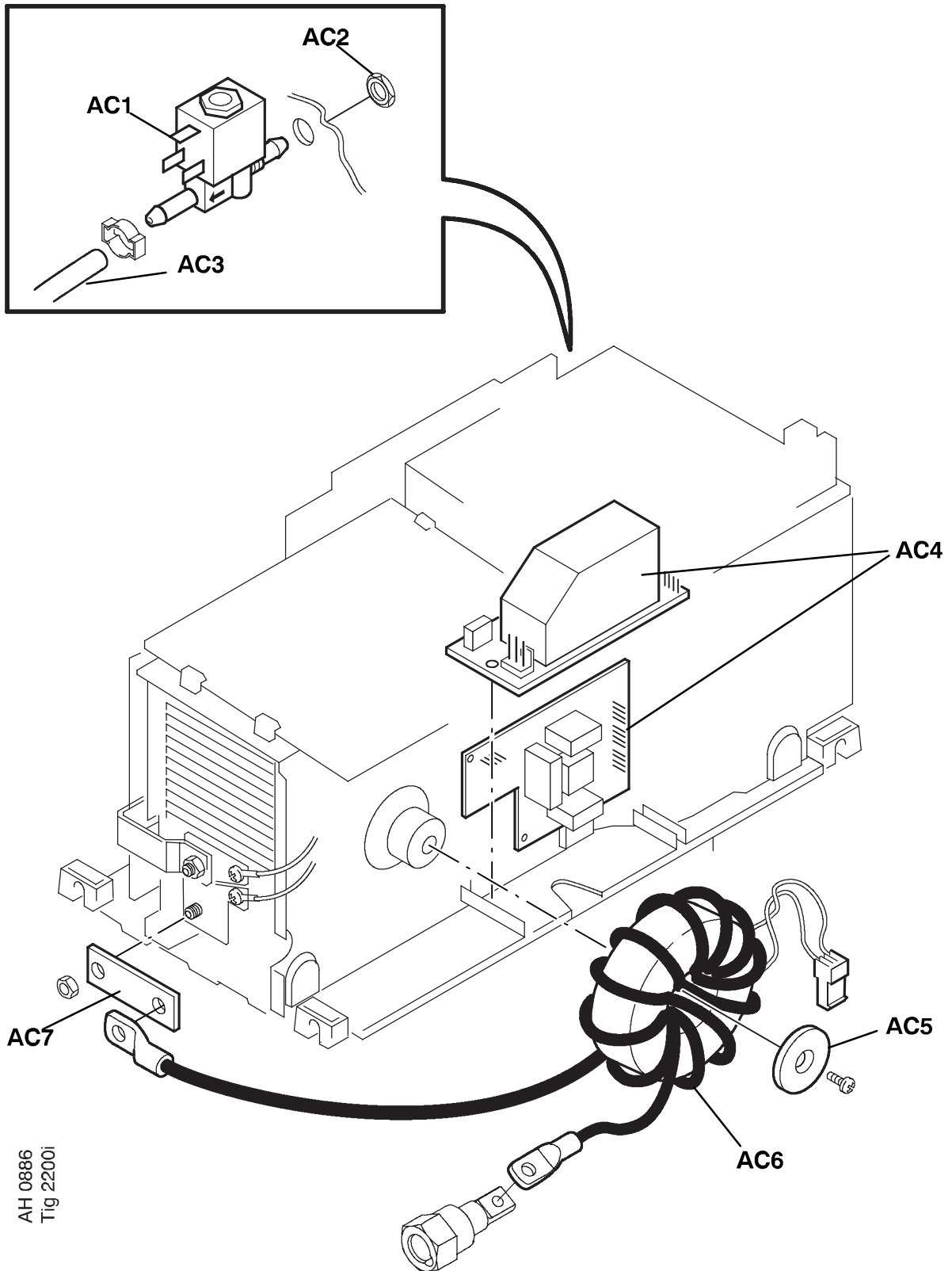

Tig 2200i





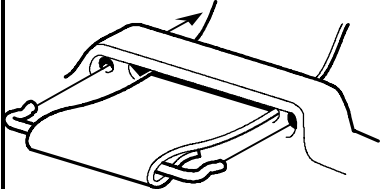
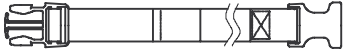

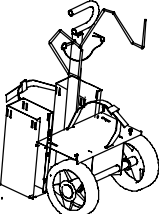

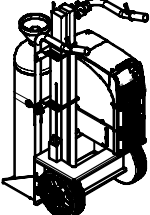
AH 0886
Tig 2200i

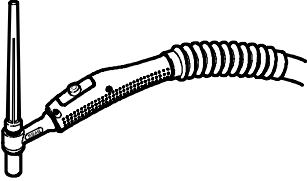
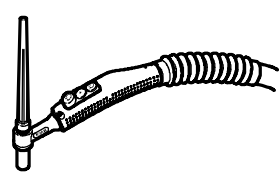

Tig 2200i

Accessories

	Strap 0460 265 001
	Cable holder 0460 265 002
	Shoulder strap 0460 265 003
	Trolley for 5-10 litre gasbottle 0459 366 885
	Trolley for 20-50 litre gasbottle 0459 366 886
	Trolley for 20-50 litre gasbottle 0460 330 880

Tig 2200i

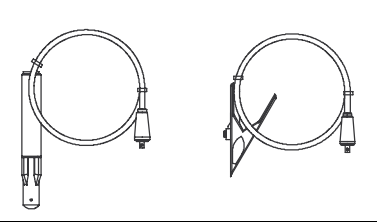
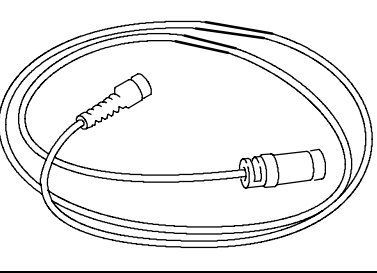
	<p>Tig torch</p> <p>TXH 150 4 m 0460 011 842</p> <p>TXH 150 8 m 0460 011 882</p> <p>TXH 200 4 m 0460 012 840</p> <p>TXH 200 8 m 0460 012 880</p> <p>TXH 250w 4 m 0460 013 840</p> <p>TXH 250w 8 m 0460 013 880</p>
	<p>Tig torch</p> <p>TXH 150r 4 m 0462 011 842</p> <p>TXH 150r 8 m 0462 011 882</p> <p>TXH 200r 4 m 0462 012 840</p> <p>TXH 200r 8 m 0462 012 880</p> <p>TXH 250wr 4 m 0462 013 840</p> <p>TXH 250wr 8 m 0462 013 880</p>
	<p>Remote control adapter RA12 12 pole 0459 491 910</p> <p>For analogue remote controls to CAN based equipment.</p>
	<p>Remote control unit MTA1 CAN 0459 491 880</p> <p>MIG/MAG: wire feed speed and voltage</p> <p>MMA: current and arc force</p> <p>TIG: current, pulse and background current</p>
	<p>Remote control unit M1 10Prog CAN 0459 491 882</p> <p>Choice of one of 10 programs</p> <p>MIG/MAG: voltage deviation</p> <p>TIG and MMA: current deviation</p>
	<p>Remote control unit AT1 CAN 0459 491 883</p> <p>MMA and TIG: current</p>
	<p>Remote control unit AT1 CF CAN 0459 491 884</p> <p>MMA and TIG: rough and fine setting of current.</p>

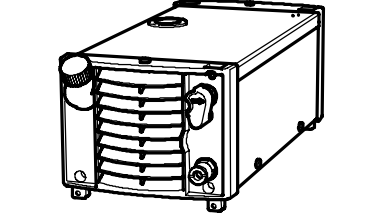
	<p>Welding cable kit 0700 006 884 Return cable kit 0700 006 885</p>
	<p>Remote cable CAN 4 pole - 12 pole 5 m 0459 544 880 10 m 0459 554 881 15 m 0459 554 882 25 m 0459 554 883 0.25 m 0459 554 884</p>
	<p>Foot pedal TI Foot CAN 0460 315 880</p>
	<p>Cooling unit CoolMini 0460 144 880 Assembly kit 0460 509 880</p>

AH 0836

